

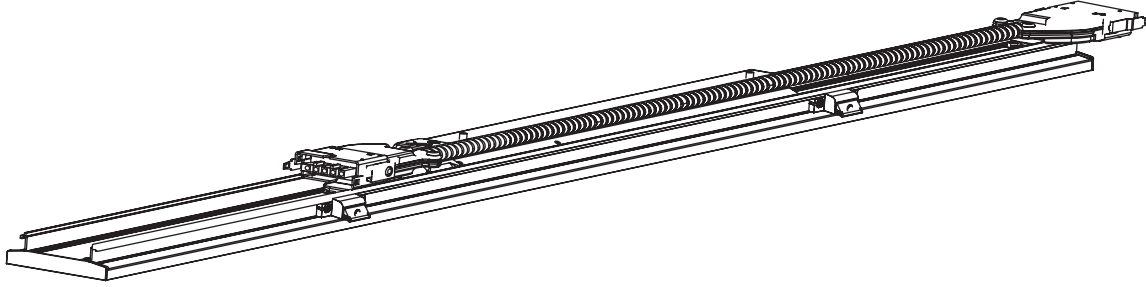









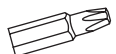

DO NOT DISCARD!



SIGN LEGEND	TOOLS REQUIRED (not included)	ACCESSORIES (optional)
 Power OFF	 T8 torx bit	 LENO release tool LENOR00700
 Power ON	 screwdriver	 4' extender cable LENOC07040
 DON'T touch the LED	 LCB4 bracket	 8' extender cable LENOC07080
 Attention	 Use ESD gloves	

24" GRID

E single through-wire 2' / 4' / 6' / 8'

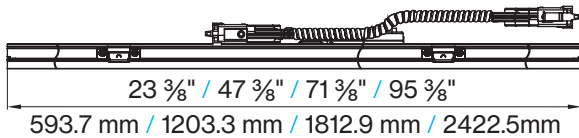

A system through-wire start/end 4'

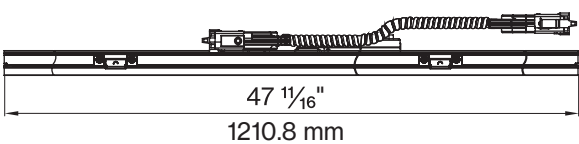

B system through-wire run/mid 2' / 4' / 6' / 8'

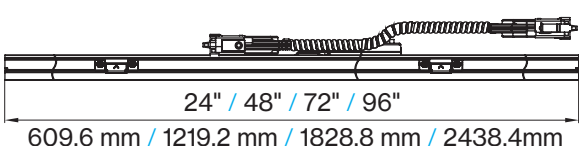

30" GRID

E single through-wire 2 1/2' / 5' / 7 1/2'

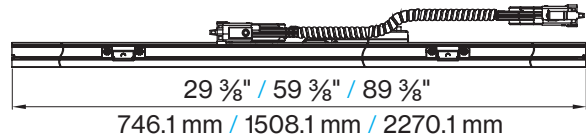

A system through-wire start/end 5'

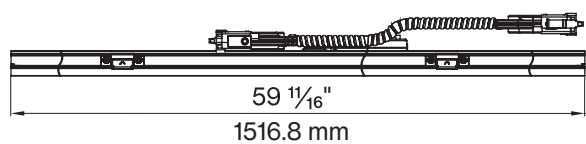

B system through-wire run/mid 2 1/2' / 5' / 7 1/2'

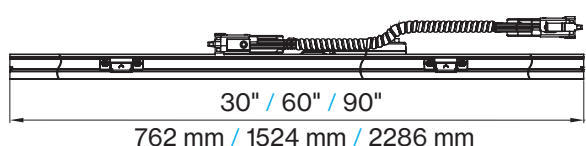

LENO 4.0 through-wire

MOUNTING INSTRUCTIONS

A single installation

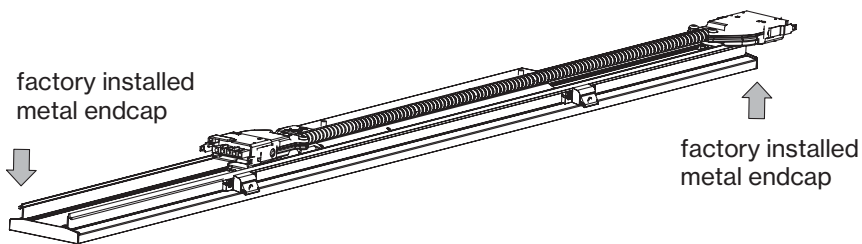

Turn off power source before installation

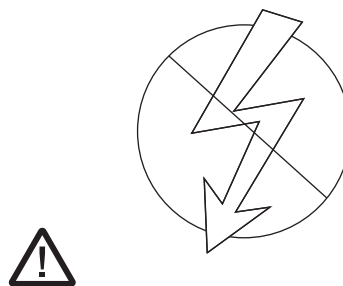

1. Visit Armstrong.com for LCB4 bracket installation (supplied by others)

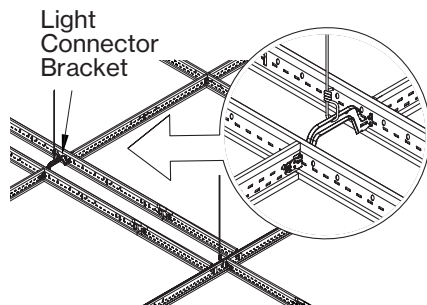
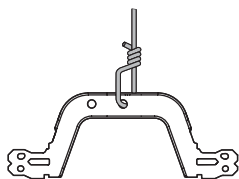

2. Connect power to junction box

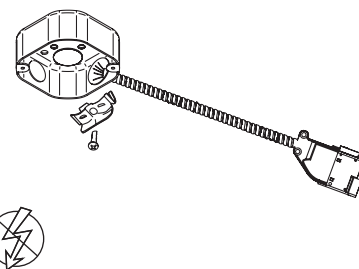

Through-wire wiring

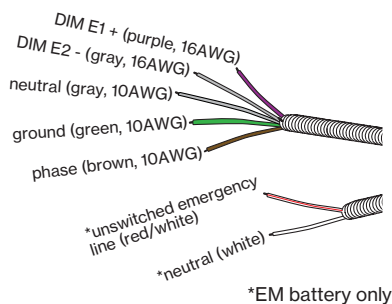

3. Close junction box

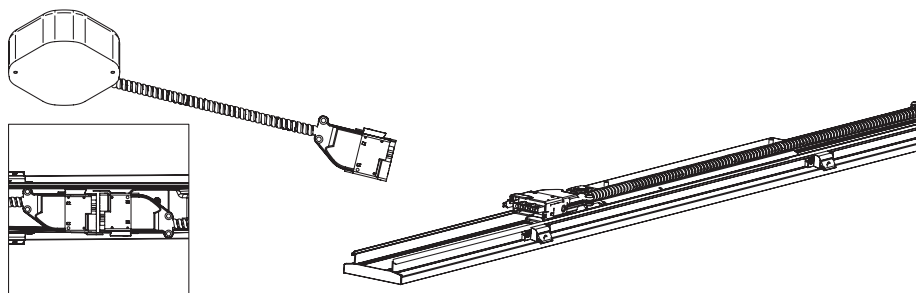

4. Line fixture up with brackets

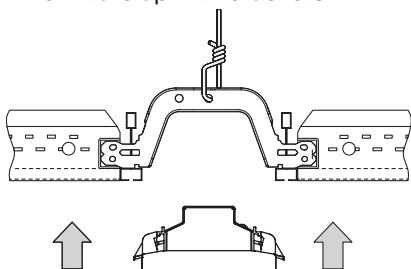

5. Snap fixture into grid ceiling. LENO makes audible CLICK when inserted.

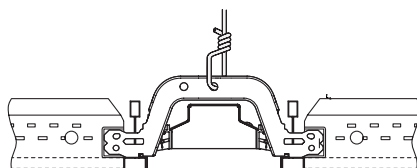

6. Installation complete

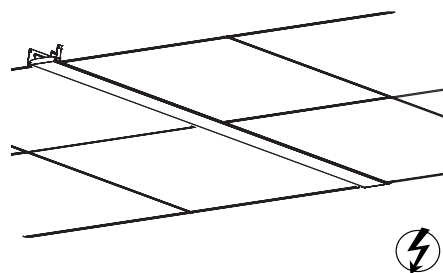

Technical Support Hotline







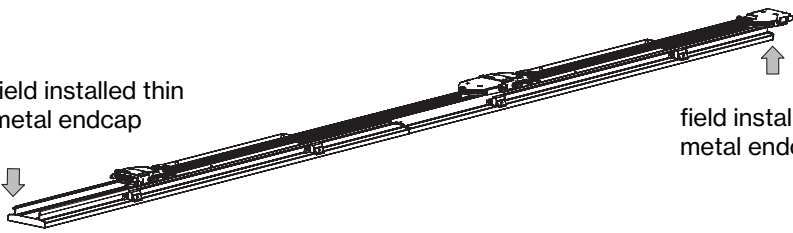
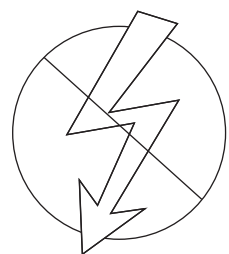

Call the Technical Support Hotline from Monday to Friday, 8 AM - 6 PM (EST)

Hotline:
+1 203 262 9990

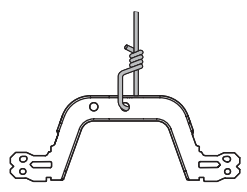
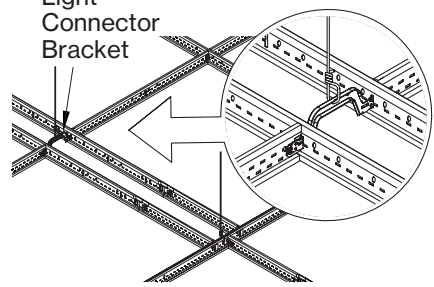
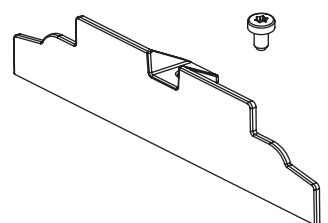
Or 24/7 via email:
support@basolighting.com

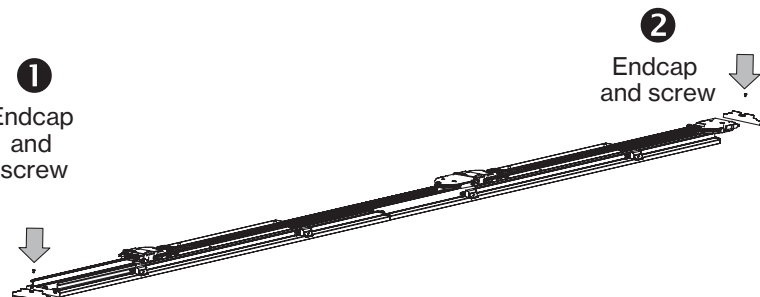
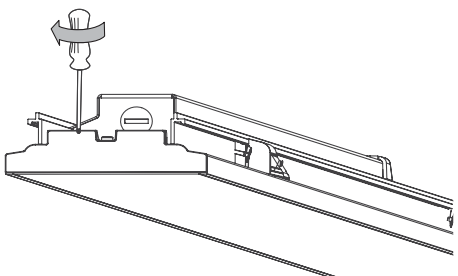
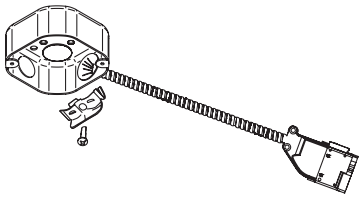
LENO 4.0 through-wire

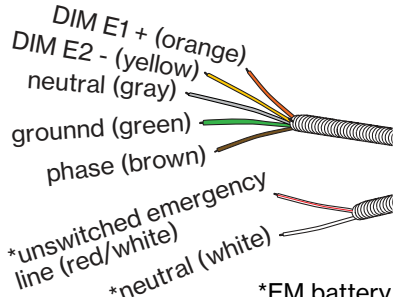
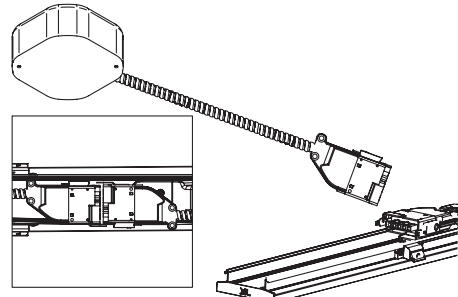
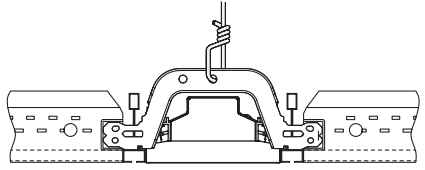
MOUNTING INSTRUCTIONS

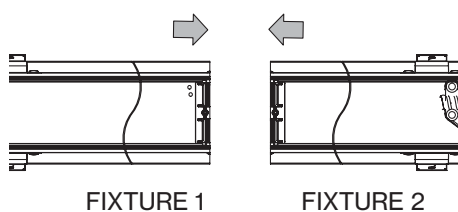
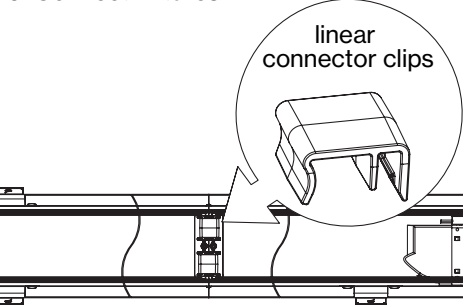
<p>Continuous installation</p>  <p>field installed thin metal endcap</p> <p>field installed thin metal endcap</p>	<p>Turn off power source before installation</p>  	
<p>1. Visit Armstrong.com for LCB4 bracket installation (supplied by others)</p> 	<p>Light Connector Bracket</p> 	<p>2. Locate the endcap and screw. Endcaps are shipped in separately in plastic bag.</p>  
<p>3. Place metal endcap on the acrylic ends of the first and last fixture.</p>  <p>1 Endcap and screw</p> <p>2 Endcap and screw</p>	<p>4. Attach endcaps using T8 torx bit</p> 	
<p>5. Connect power to junction box</p>  	<p>Through-wire wiring</p> <ul style="list-style-type: none"> DIM E1 + (orange) DIM E2 - (yellow) neutral (gray) ground (green) phase (brown) *unswitched emergency line (red/white) *neutral (white) *EM battery only 	<p>6. Connect power feed to fixture</p> 
<p>7. Snap fixture into place, one fixture at a time. LENO makes audible CLICK when inserted.</p>  	<p>8. Once in grid, push fixtures together so there are no visible spaces.</p>  <p>FIXTURE 1</p> <p>FIXTURE 2</p>	<p>9. Connect fixtures.</p>  <p>linear connector clips</p>

LENO 4.0 through-wire

MOUNTING INSTRUCTIONS

NON-EMERGENCY THROUGH-WIRE RUN

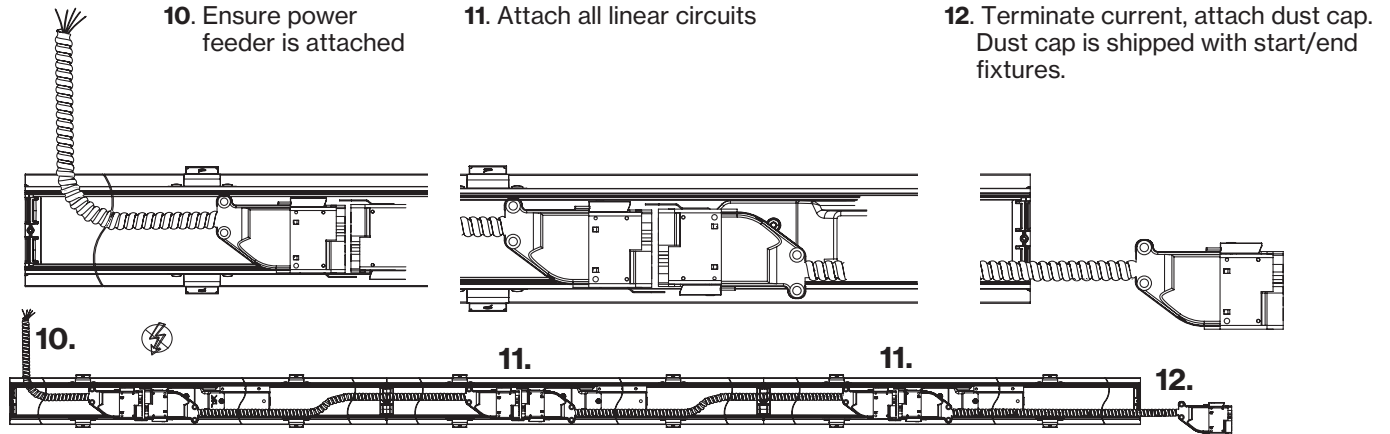

OPTIONAL EM BATTERY THROUGH-WIRE RUN

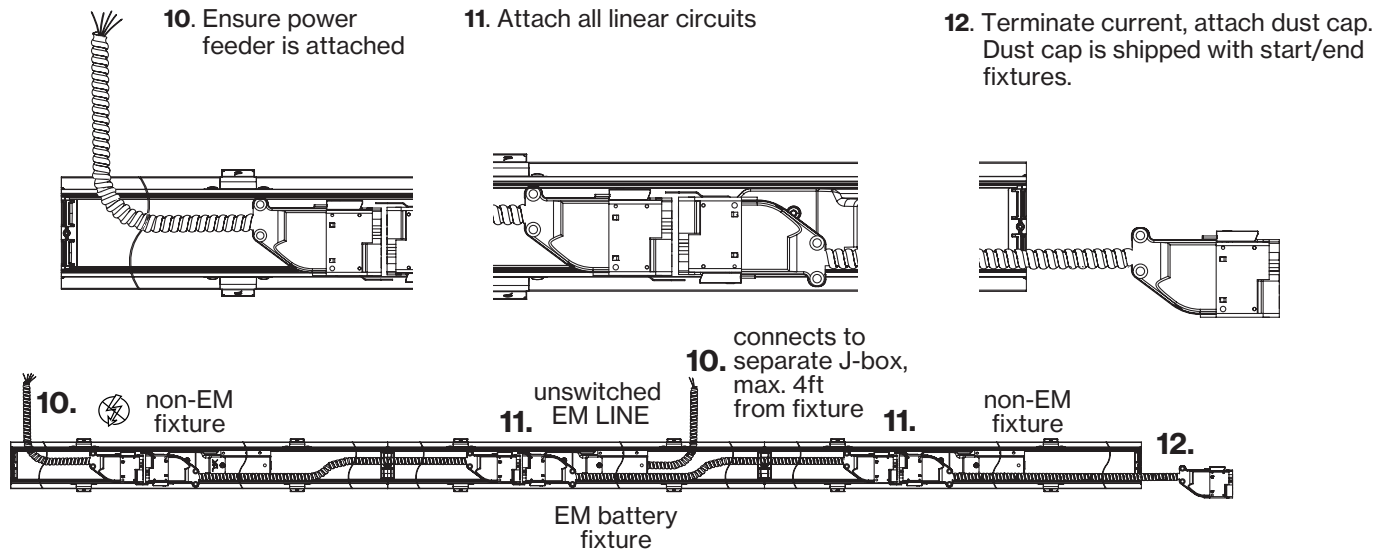

OPTIONAL EM CIRCUIT THROUGH-WIRE RUN

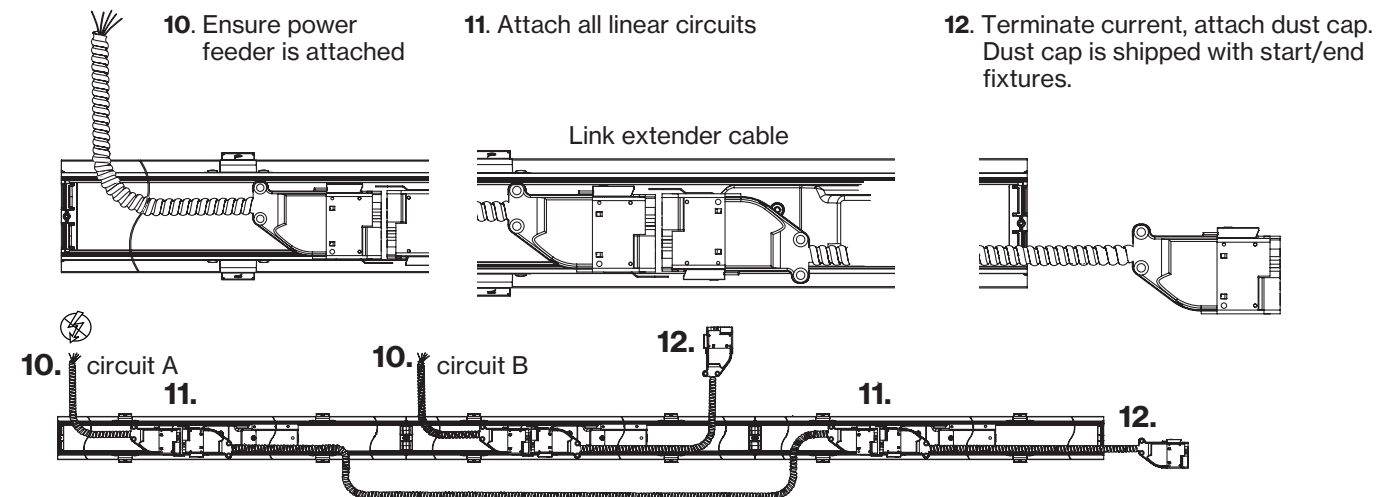

LENO 4.0 through-wire

MOUNTING INSTRUCTIONS

16. Installation complete

1. Turn off power source before uninstalling

2. To uninstall squeeze black metal clips

3. While squeezing clips, pull connectors apart

4. Lightly press up at end of fixture

5. While pressing, slide release tool into grid. Hook should wrap around locking mechanism.

6. Carefully pull release tool down. Click should be audible once released. Repeat for all fixtures.

Single and continuous run configurations

24" ceiling tiles

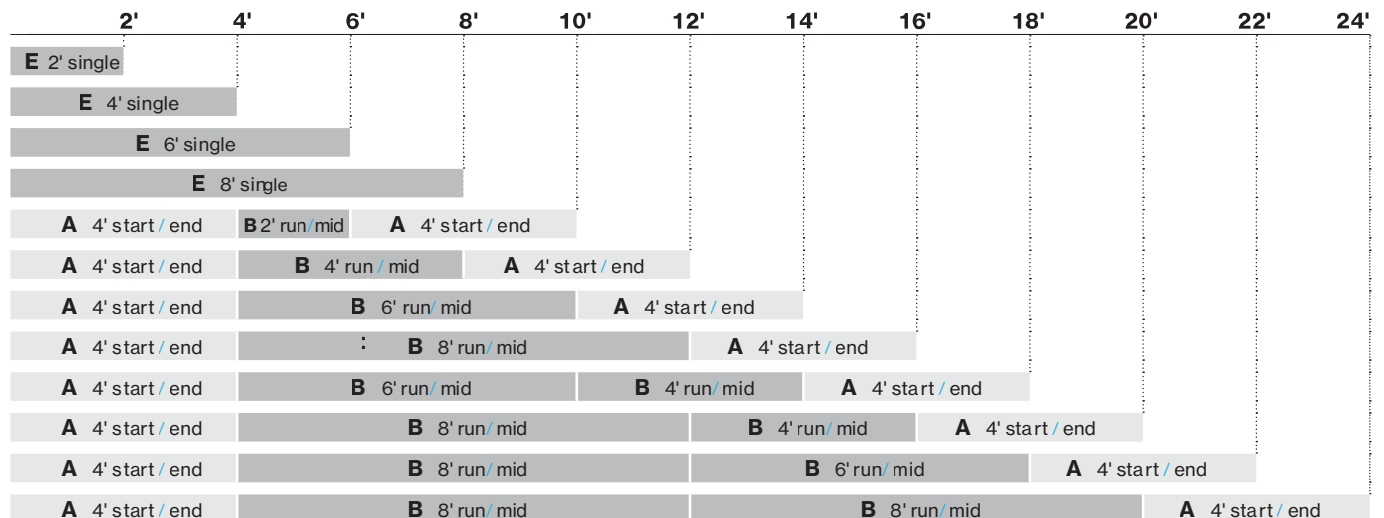

LENO 4.0 through-wire

MOUNTING INSTRUCTIONS

30" ceiling tiles

	2 1/2'	5'	7 1/2'	10'	12 1/2'	15'	17 1/2'	20'	22 1/2'	25'	27 1/2'	30'
E 2 1/2' single												
E 5' single												
E 7 1/2' single												
A 5' start/end			A 5' start / end									
A 5' start/end	B 2 1/2' run / mid		A 5' start / end									
A 5' start/end	B 5' run / mid		A 5' start / end									
A 5' start/end	B 7 1/2' run / mid		A 5' start / end									
A 5' start/end	B 5' run / mid		B 5' run / mid		A 5' start / end							
A 5' start/end	B 7 1/2' run / mid		B 5' run / mid		A 5' start / end							
A 5' start/end	B 7 1/2' run / mid		B 7 1/2' run / mid		A 5' start / end							
A 5' start/end	B 5' run / mid		B 5' run / mid		B 7 1/2' run / mid		A 5' start / end					
A 5' start/end	B 7 1/2' run / mid		B 5' run / mid		B 7 1/2' run / mid		A 5' start / end					

Technical Support Hotline

Call the Technical Support Hotline from Monday to Friday, 8 AM - 6 PM (EST)

Hotline:
+1 203 262 9990

Or 24/7 via email:
support@basolighting.com

EN Installation, commissioning and maintenance may only be performed by authorized and qualified personnel, taking into consideration these installation instructions and any standards and regulations applicable to the respective area of application. The electrical, mechanical and thermal suitability of the luminaire for the intended area of application must be ensured and the secure fastening of the luminaire after its installation must be controlled. Turn off supply voltage before replacing any lamps (if applicable) as well as before performing any other works on the luminaire (e.g. cleaning) and wait until luminaire and lamp have completely cooled off. Please refer to the installation notes of the lamp manufacturer when inserting, replacing and operating conventional lamps. Use a soft, damp cloth to clean the luminaire. To clean plastic components and reflectors, a standard pH neutral, alcohol-free, non-abrasive cleaning agent may also be used.

Keep these installation instructions in a safe place as reference for any future maintenance works.

- The lamp is not suitable for outdoor use.
- The lamp may only be used with a safety guard.
- Damaged protection glasses and covers have to be replaced immediately.
- Corrosive chemical products must not be used as this may have a detrimental effect on the luminaire.
- No liability is accepted for any subsequent change of the luminaire.
- LEDs are high-quality electronic components! Please avoid touching by hand the LED light emitting surface while assembling or replacing parts and during maintenance work.
- To avoid damage of the profile, unevenness on the wall or ceiling must be leveled out before assembling the profiles. While assembling the profiles, make sure they do not deform in order to guarantee their proper function.
- The light source contained in this luminaire shall only be replaced by the manufacturer or his service agent or a similar qualified person.
- The LED circuit must always be closed, before the converter is connected to the main power. BASO does not assume any liability for damages resulting from nonobservance of this rule.
- Luminous flux and connected electrical load are subject to an initial tolerance of up to +/-10%. Color temperature is subject to a tolerance of up to +/-150 Kelvin from the nominal value.

ES Le montage et la maintenance peut être effectué par spécialistes respectant les normes y régles valides. Assurer l'aptitude thermique, mécanique et électrique pour l'emploi prévue et assurer la fixation de la luminaires. Éteindre la tension avant de changer les lampes (si applicable) ou avant de réaliser travaux (p.ex nettoyage) a la luminaires. Attendre jusqu'à ce que la luminaires et les lampes ont fraichit complètement. Merci de bien vouloir vous référer aux notes d'installation du fabricant de la lampe lors de l'insertion, le remplacement et la mise en route, avec des lampes conventionnelles. Pour nettoyer la luminaires utiliser un drap humide et doux. Pour nettoyer les parties du plastique ou les réflecteurs on peut utiliser encore un produit de nettoyage sans alcool qui ne fraye pas le material. Garder cette notice de montage pour possibles travaux de maintenance.

- La luminaires n'est pas apte pour l'utilisation extérieure.
- Utiliser la luminaires seulement avec un dispositif de sécurité.
- Changer immédiatement des verres de sécurité défectueux ou bien des écrans de protection.
- Évitez tout contact de la lampe avec de produits chimiques corrosifs.
- Nous déclinons toute responsabilité en cas de modifications ultérieures.
- Des LEDs sont des composants électroniques de haute qualité! Éviter tout contact direct de la surface de sortie de lumière de la LED avec les mains lors du montage ou des les travaux de maintenance de la lampe.
- Pour éviter l'endommagement du profil, il est nécessaire de compenser les irrégularités du mur ou du plafond avant le montage des profils. Pour garantir un fonctionnement irréprochable des profils, il ne faut pas déformer les profils lors du montage.
- La source du luminaires peut être remplacé uniquement par le fabricant ou un tiers habilité.
- Il faut que le circuit de LED soit fermé avant de connecter le convertisseur. BASO ne assume pas la garantie si cette norme ne se respecte pas.
- La puissance et le flux lumineux affichent d'origine une tolérance de +/-10%. Tolérance de la couleur de température : +/- 150 Kelvin.

FR La instalación, la puesta en marcha y el mantenimiento sólo deben realizarse por personal especializado considerando esta guía de instalación y todas las normas y reglamentaciones vigentes. Asegurarse de la aptitud eléctrica, mecánica y térmica de la luminaria para la aplicación prevista y comprobar la fijación segura de la luminaria después de su instalación. Apagar siempre la corriente antes de cambiar la lámpara (en caso justificado) o de realizar algún otro trabajo en esta (p.ej. Limpieza). Esperar hasta que se enfríen la luminaria y la lámpara completamente. Tener en cuenta las instrucciones de montaje del fabricante al colocar, cambiar y utilizar lámparas convencionales. Para la limpieza de la luminaria utilizar un paño suave y húmedo. Para limpiar componentes de plástico y reflectores puede usar también un limpiador pH neutral y sin alcohol que no roce el material. Guardar esta guía de instalación para trabajos de mantenimiento.

- La luminaria no es apta para utilizarla en el exterior.
- En esta (p.ej. Limpieza). Esperar hasta que se enfríen la luminaria y la lámpara completamente. Tener en cuenta las instrucciones de montaje del fabricante al colocar, cambiar y utilizar lámparas convencionales. Para la limpieza de la luminaria
- La luminaria solo debe accionar con un dispositivo de seguridad.
- Cambie de inmediato los vidrios y las tapas de protección dañados.
- Para modificaciones futuras en la luminaria no se asume ninguna responsabilidad.
- Los LEDs son componentes electrónicos de alta calidad! Por favor durante el montaje o el mantenimiento evite el contacto directo con la superficie de emisión.
- Para evitar danos en el perfil, los desníveles de las paredes y techos deben ser enrasados antes del montaje de los perfiles. Para garantizar su buen funcionamiento, los perfiles no deben sufrir deformaciones durante el montaje.
- La fuente luminosa contenida en esta luminaria debe ser reemplazada únicamente por el fabricante o su agente de servicio o similar persona cualificada.
- El circuito LED debe ser cerrado antes de conectar el convertidor. BASO no asume garantía si esta norma no se respeta.
- Los datos de flujo luminoso y potencia son inicialmente pasibles de tolerancias de +/- 10%. Tolerancia de la temperatura de color: +/- 150 Kelvin.

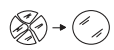

The lamp may only be operated with its full protective cover!

L'apparechio necessita del relativo vetro di protezione!



Sólo usar la luminaria con su cobertura de seguridad completa!



Recommended room temperature: 77 °F.

Temperatura ambiente recomendada: 77 °F.

Température ambiante recommandée: 77 °F.



Don't touch the LED



Use gloves.

Use guantes.

Utiliser des gants.

LENO 4.0 whip

MOUNTING INSTRUCTIONS

DO NOT DISCARD!

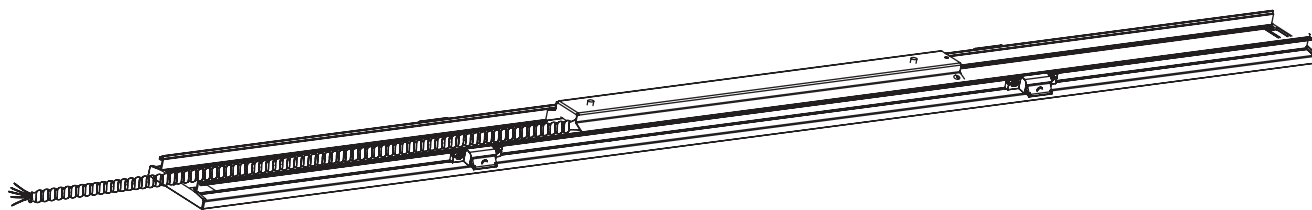

SIGN LEGEND



Power OFF



Power ON



DON'T touch the LED



Attention

TOOLS REQUIRED (not included)

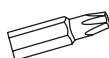

T8 torx bit



screwdriver



LCB4 bracket



Use ESD gloves

ACCESSORIES (optional)



LENO release tool
LENOR00700

24" GRID

E single whip 2' / 4' / 6' / 8'

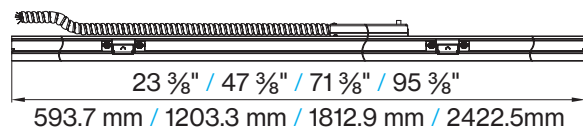

A system whip start/end 4'

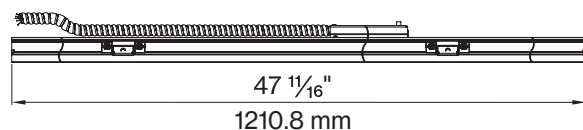

B system whip run/mid 2' / 4' / 6' / 8'

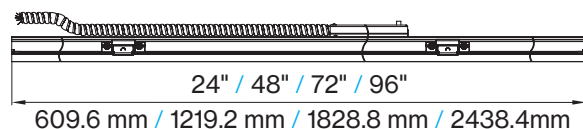

30" GRID

E single whip 2 1/2' / 5' / 7 1/2'

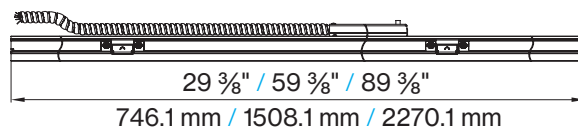

A system whip start/end 5'

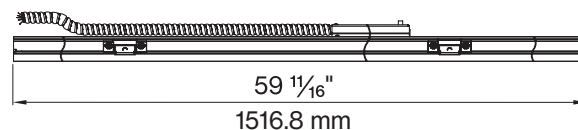

B system whip run/mid 2 1/2' / 5' / 7 1/2'

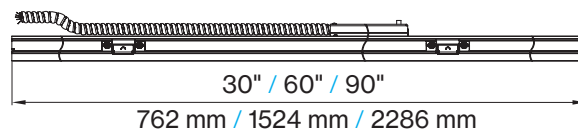

LENO 4.0 whip

MOUNTING INSTRUCTIONS

A single installation

factory installed
metal endcap

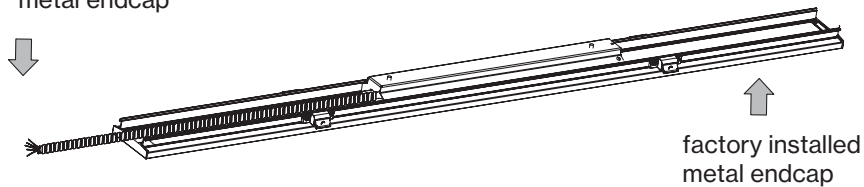

Turn off power source before installation

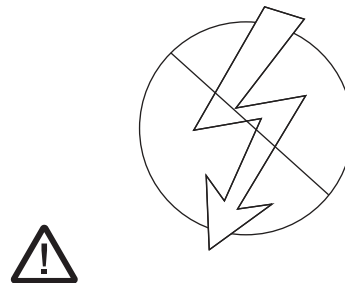

1. Visit Armstrong.com for LCB4 bracket
installation (supplied by others)

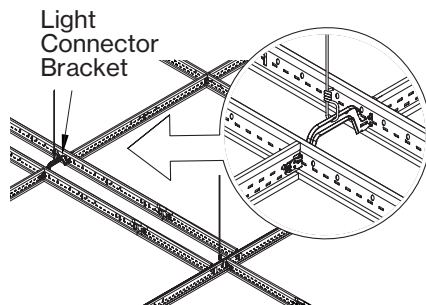
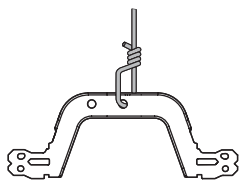

2. Connect whip to junction box

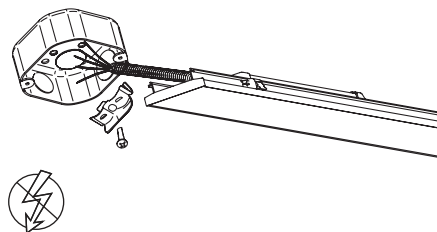

Whip wiring

*unswitched emergency
line (red/white)
*EM battery only
DIM E1 + (orange)
DIM E2 - (yellow)
neutral (white)
ground (green)
phase (black)

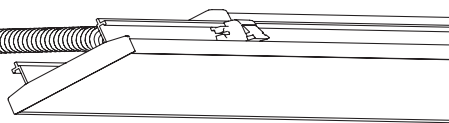

3. Close junction box

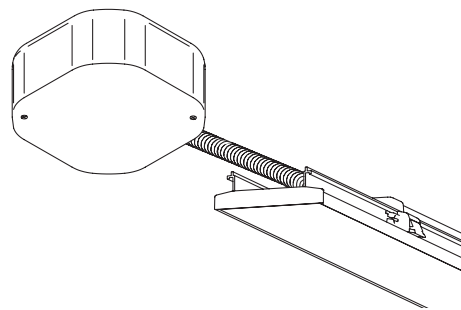

4. Line fixture up with brackets

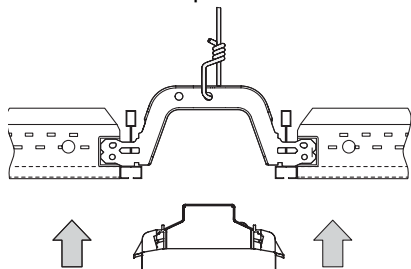

5. Snap fixture into grid ceiling. LENO
makes audible CLICK when inserted.

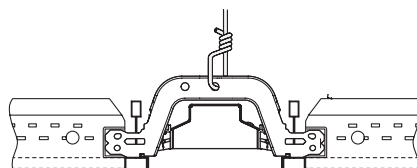

6. Installation complete

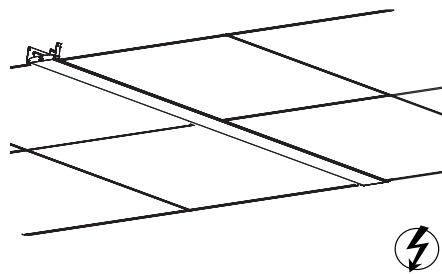

Technical Support Hotline







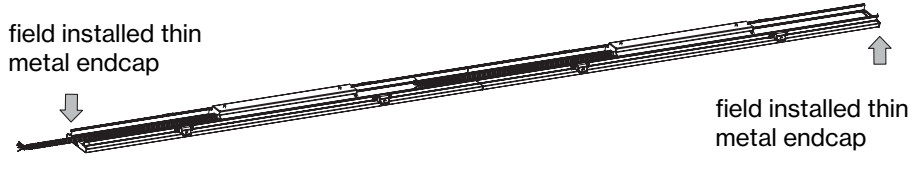
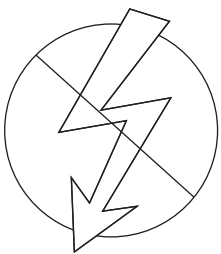

Call the Technical Support Hotline from
Monday to Friday, 8 AM - 6 PM (EST)

Hotline:
+1 203 262 9990

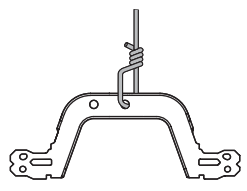
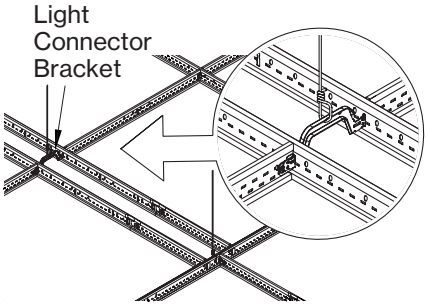
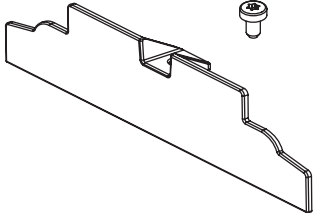
Or 24/7 via email:
support@basolighting.com

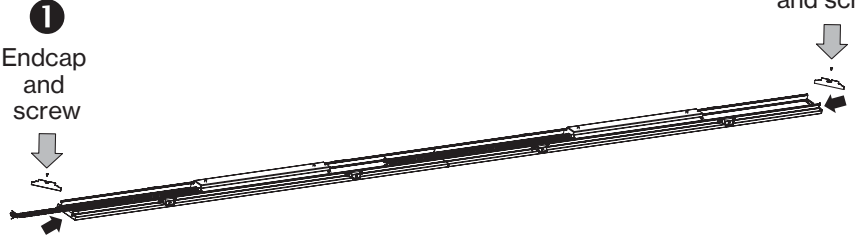
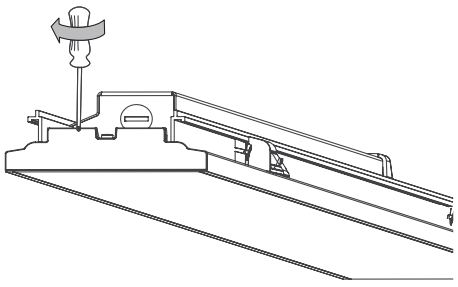
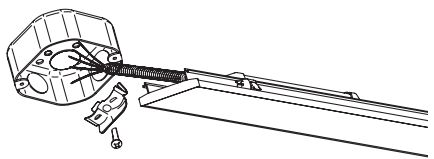
LENO 4.0 whip

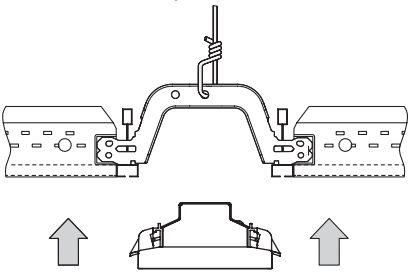
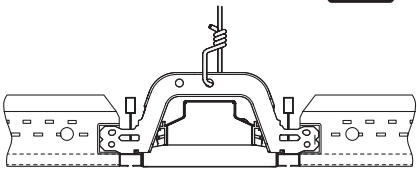
MOUNTING INSTRUCTIONS

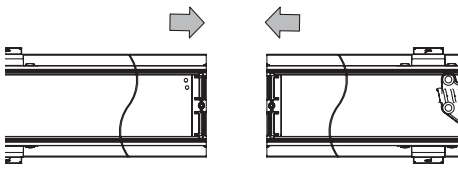
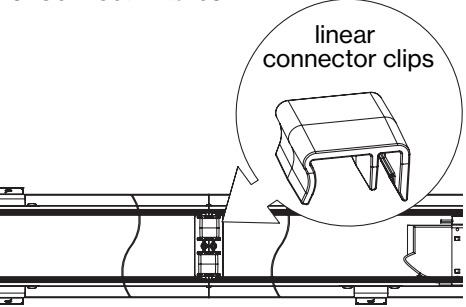
<p>Continuous installation</p> 	<p>Turn off power source before installation</p>  	
<p>1. Visit Armstrong.com for LCB4 installation (supplied by others)</p>  	<p>2. Locate the endcap and screw. Endcaps are shipped in separately in plastic bag.</p>  	
<p>3. Place metal endcap on the acrylic ends of the first and last fixture.</p>  <p>1 Endcap and screw</p> <p>2 Endcap and screw</p>	<p>4. Attach endcaps using T8 torx bit</p> 	
<p>5. Connect whip to junction box</p>   <p>Whip wiring</p> <ul style="list-style-type: none"> *unswitched emergency line (red/white) *EM battery only DIM E1 + (orange) DIM E2 - (yellow) neutral (white) ground (green) phase (black) 	<p>6. Line fixture up with brackets</p> 	
<p>7. Snap fixture into place, one fixture at a time. LENO makes audible CLICK when inserted.</p>  	<p>8. Once in grid, push fixtures together so there are no visible spaces.</p>  <p>FIXTURE 1 FIXTURE 2</p>	<p>9. Connect fixtures.</p>  <p>linear connector clips</p>

LENO 4.0 whip

MOUNTING INSTRUCTIONS

10. WHIP

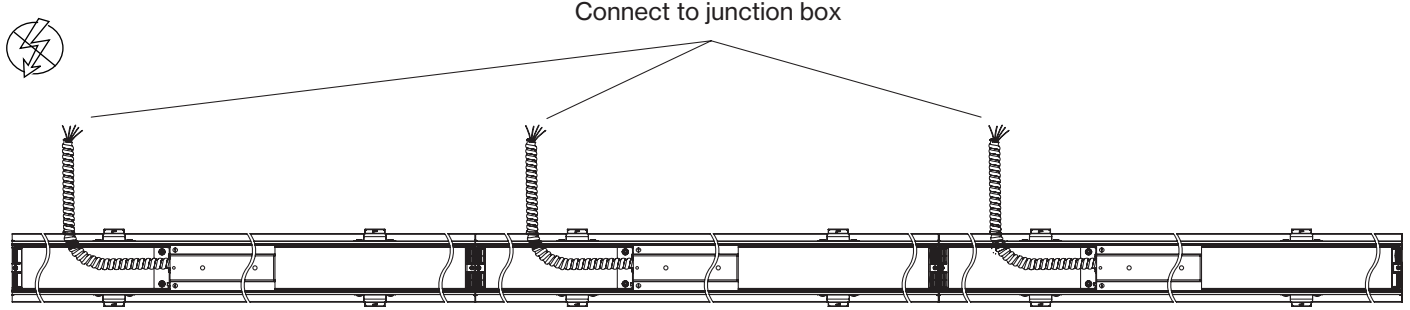

11. Installation complete

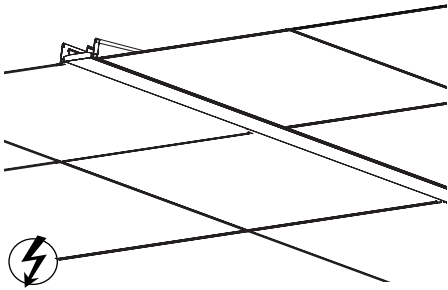

1. Turn off power source before uninstalling

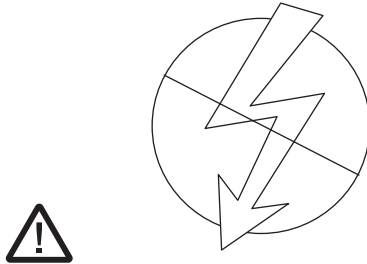

2. Lightly press up at end of fixture

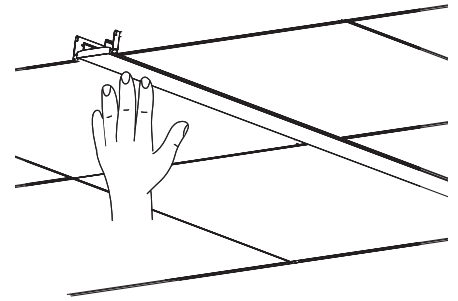

3. While pressing, slide release tool into grid. Hook should wrap around locking mechanism.

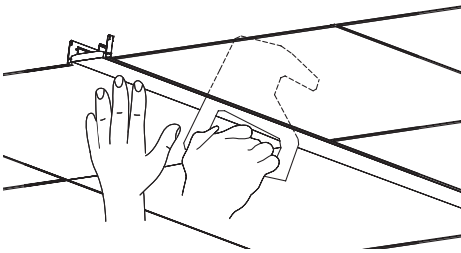

4. Carefully pull release tool down. Click should be audible once released. Repeat for all fixtures.

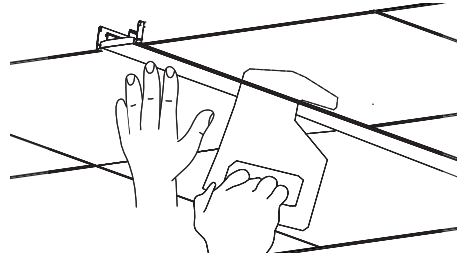

Single and continuous run configurations

24" ceiling tiles

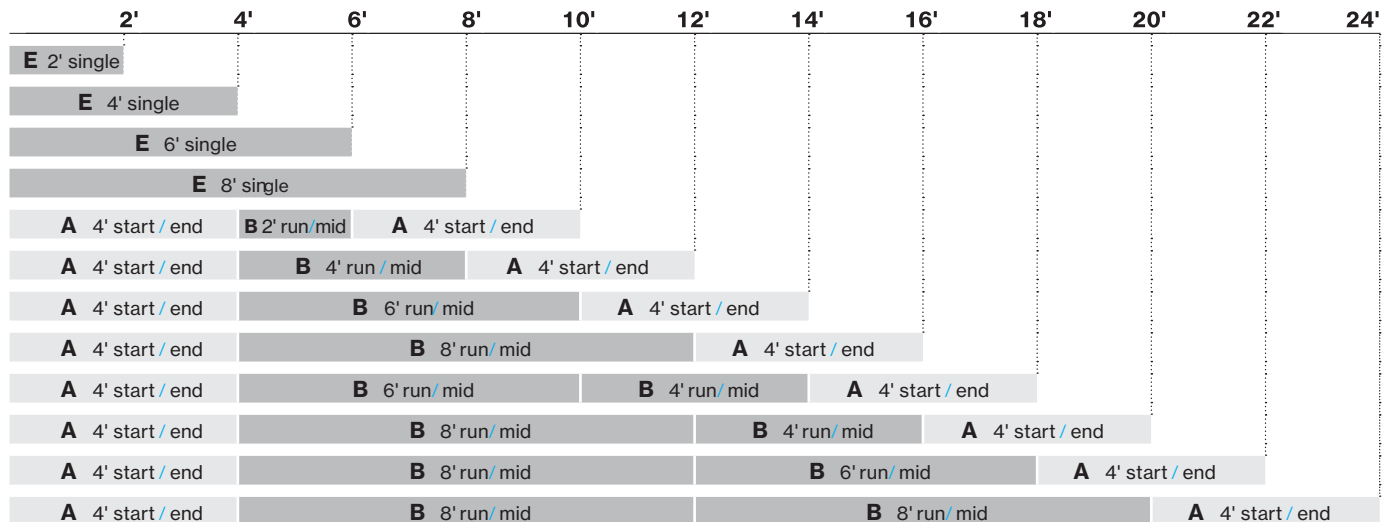

LENO 4.0 whip

MOUNTING INSTRUCTIONS

30" ceiling tiles

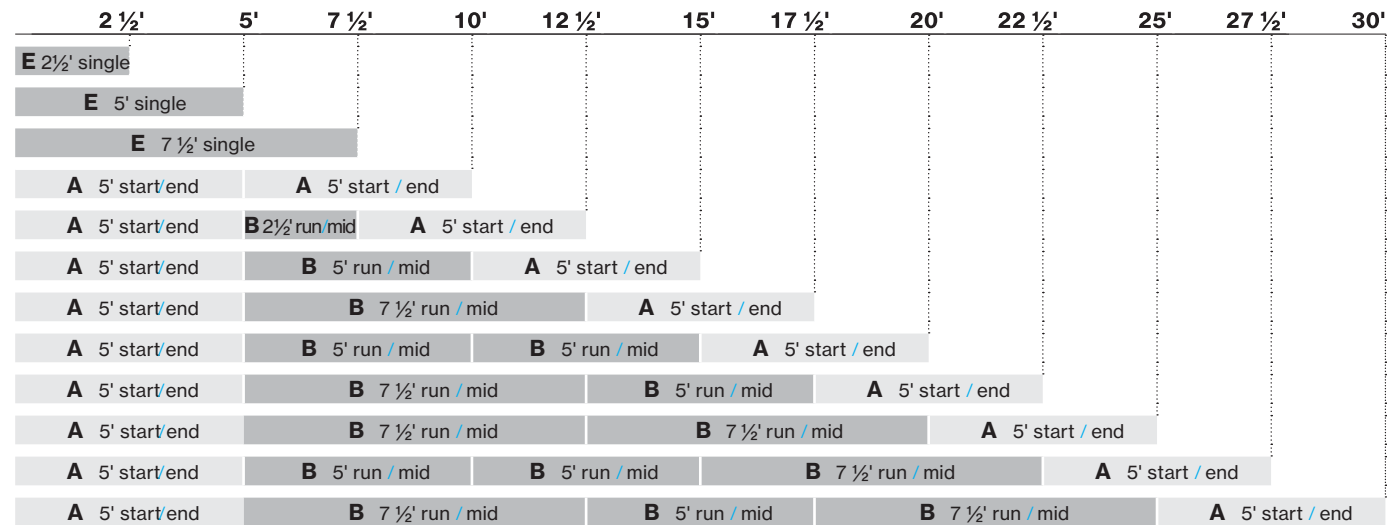

Technical Support Hotline

Call the Technical Support Hotline from Monday to Friday, 8 AM - 6 PM (EST)

Hotline:
+1 203 262 9990

Or 24/7 via email:
support@basolighting.com

EN Installation, commissioning and maintenance may only be performed by authorized and qualified personnel, taking into consideration these installation instructions and any standards and regulations applicable to the respective area of application. The electrical, mechanical and thermal suitability of the luminaire for the intended area of application must be ensured and the secure fastening of the luminaire after its installation must be controlled. Turn off supply voltage before replacing any lamps (if applicable) as well as before performing any other works on the luminaire (e.g. cleaning) and wait until luminaire and lamp have completely cooled off. Please refer to the installation notes of the lamp manufacturer when inserting, replacing and operating conventional lamps. Use a soft, damp cloth to clean the luminaire. To clean plastic components and reflectors, a standard pH neutral, alcohol-free, non-abrasive cleaning agent may also be used.

Keep these installation instructions in a safe place as reference for any future maintenance works.

- The lamp is not suitable for outdoor use.
- The lamp may only be used with a safety guard.
- Damaged protection glasses and covers have to be replaced immediately.
- Corrosive chemical products must not be used as this may have a detrimental effect on the luminaire.
- No liability is accepted for any subsequent change of the luminaire.
- LEDs are high-quality electronic components! Please avoid touching by hand the LED light emitting surface while assembling or replacing parts and during maintenance work.
- To avoid damage of the profile, unevenness on the wall or ceiling must be leveled out before assembling the profiles. While assembling the profiles, make sure they do not deform in order to guarantee their proper function.
- The light source contained in this luminaire shall only be replaced by the manufacturer or his service agent or a similar qualified person.
- The LED circuit must always be closed, before the converter is connected to the main power. BASO does not assume any liability for damages resulting from nonobservance of this rule.
- Luminous flux and connected electrical load are subject to an initial tolerance of up to +/-10%. Color temperature is subject to a tolerance of up to +/- 150 Kelvin from the nominal value.

ES Le montage et la maintenance peut être effectué par spécialistes respectant les normes y régles valides. Assurer l'aptitude thermique, mécanique et électrique pour l'emploi prévu et assurer la fixation de la luminaire. Éteindre la tension avant de changer les lampes (si applicable) ou avant de réaliser travaux (p.ex nettoyage) à la luminaire. Attendre jusqu'à ce que la luminaire et les lampes ont fraichit complètement. Merci de bien vouloir vous référer aux notes d'installation du fabricant de la lampe lors de l'insertion, le remplacement et la mise en route, avec des lampes conventionnelles. Pour nettoyer la luminaire utiliser un drap humide et doux. Pour nettoyer les parties du plastique ou les réflecteurs on peut utiliser encore un produit de nettoyage sans alcool qui ne fraye pas le material. Garder cette notice de montage pour possibles travaux de maintenance.

- La luminaire n'est pas apte pour l'utilisation extérieure.
- Utiliser la luminaire seulement avec un dispositif de sécurité.
- Changer immédiatement des verres de sécurité defectes ou bien des écrans de protection.
- Évitez tout contact de la lampe avec de produits chimiques corrosifs.
- Nous déclinons toute responsabilité en cas de modifications ultérieures.
- Des LEDs sont des composants électroniques de haute qualité! Éviter tout contact direct de la surface de sorti de lumière de la LED avec les mains lors du montage ou des travaux de maintenance de la lampe.
- Pour éviter l'endommagement du profil, il est nécessaire de compenser les irrégularités du mur ou du plafond avant le montage des profils. Pour garantir un fonctionnement irréprochable des profils, il ne faut pas déformer les profils lors du montage.
- La source du luminaire peut être remplacé uniquement par le fabricant ou un tiers habilité.
- Il faut que le circuit de LED soit fermé avant de connecter le convertisseur. BASO ne assume pas la garantie si cette norme ne se respecte pas.
- La puissance et le flux lumineux affichent d'origine une tolérance de +/-10%. Tolérance de la couleur de température : +/- 150 Kelvin.

FR La instalación, la puesta en marcha y el mantenimiento sólo deben realizarse por personal especializado considerando esta guía de instalación y todas las normas y reglamentaciones vigentes. Asegurarse de la aptitud eléctrica, mecánica y térmica de la luminaria para la aplicación prevista y comprobar la fijación segura de la luminaria después de su instalación. Apagar siempre la corriente antes de cambiar la lámpara (en caso justificado) o de realizar algún otro trabajo en esta (p.ej. Limpieza). Esperar hasta que se enfríen la luminaria y la lámpara completamente. Tener en cuenta las instrucciones de montaje del fabricante al colocar, cambiar y utilizar lámparas convencionales. Para la limpieza de la luminaria utilizar un paño suave y húmedo. Para limpiar componentes de plástico y reflectores puede usar también un limpiador pH neutral y sin alcohol que no roce el material. Guardar esta guía de instalación para trabajos de mantenimiento.

- La luminaria no es apta para utilizarla en el exterior.
- La luminaria sólo debe accionar con un dispositivo de seguridad.
- Cambie de inmediato los vidrios y las tapas de protección dañados.
- Químicos que tienen efectos corrosivos no deben influir en la luminaria.
- Para modificaciones futuras en la luminaria no se asume ninguna responsabilidad.
- Los LED son componentes electrónicos de alta calidad! Por favor durante el montaje o el mantenimiento evite el contacto directo con la superficie de emisión.
- Para evitar daños en el perfil, los desvíos de las paredes y techos deben ser enrasados antes del montaje de los perfiles. Para garantizar su buen funcionamiento, los perfiles no deben sufrir deformaciones durante el montaje.
- La fuente luminosa contenida en esta luminaria debe ser reemplazada únicamente por el fabricante o su agente de servicio o similar persona cualificada.
- El circuito LED debe ser cerrado antes de conectar el convertidor. BASO no asume garantía si esta norma no se respeta.
- La potencia y el flujo luminoso e potencia son inicialmente pasibles de toleranzas de +/- 10%. Tolerancia de la temperatura de colore: +/- 150 Kelvin.

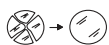

The lamp may only be operated with its full protective cover!

L'apparechio necessita del relativo vetro di protezione!

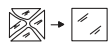

Sólo usar la luminaria con su cobertura de seguridad completa!



Recommended room temperature: 77 °F.

Temperatura ambiente recomendada: 77 °F.

Température ambiante recommandée: 77 °F.



Don't touch the LED



Use gloves.

Use guantes.

Utiliser des gants.